

SECTION II

TM9-2330-207-24P

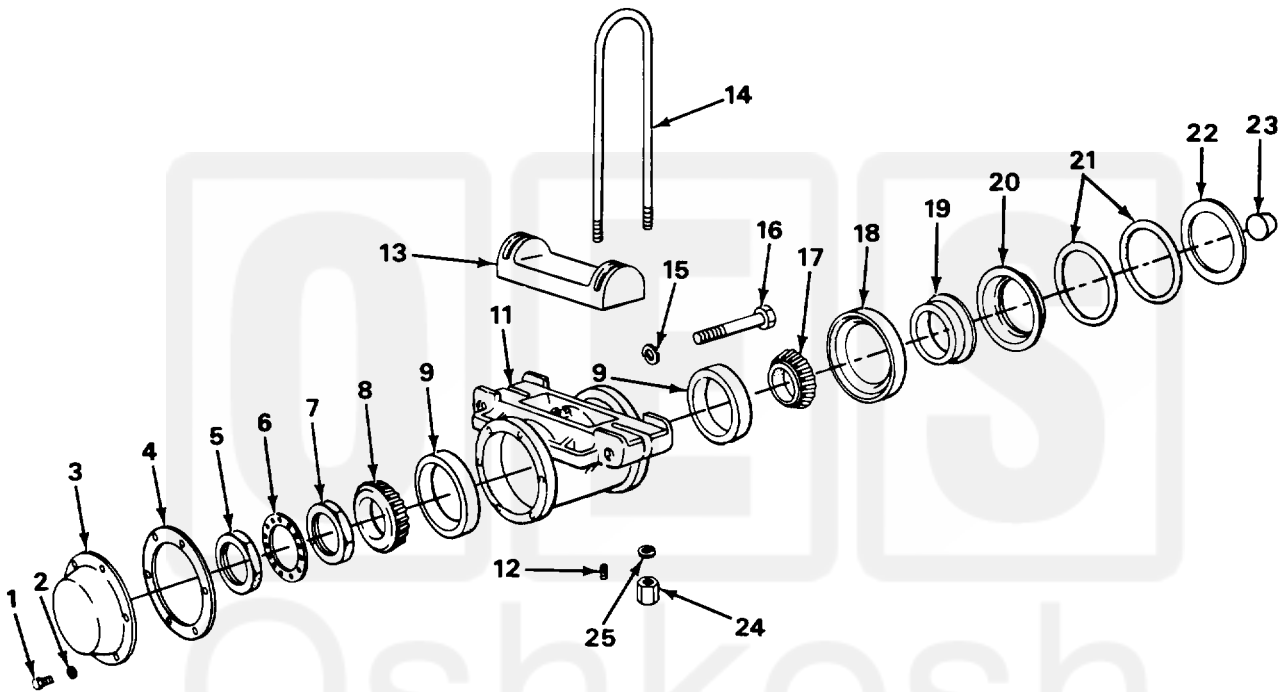

TA706133

FIGURE 51. SPRING SEAT AND BEARINGS.

Current part is item (21) on diagram. Available at www.oshkoshequipment.com

SECTION (1)	II (2)	TM9-2330-207-24P (3)	(4)	(5)	(6)
ITEM NO	SMR CODE	CAGEC	PART NUMBER	DESCRIPTION AND USABLE ON CODES (UOC)	QTY
GROUP 16 SPRINGS AND SHOCK ABSORBERS					
GROUP 1601 SPRINGS					
FIG. 51 SPRING SEAT AND BEARINGS					
1	PAOZZ	96906	MS90728-30	BOLT, MACHINE	12
2	PAOZZ	96906	MS35338-45	WASHER, LOCK	12
3	PAOZZ	19207	7979306	COVER, ACCESS	2
4	PAOZZ	19207	7979274	GASKET	2
5	PAOZZ	19207	7979263	NUT, PLAIN, OCTAGON	2
6	PAOZZ	19207	5139123	WASHER, KEY	2
7	PAOZZ	19207	7979308	NUT, PLAIN, OCTAGON	2
8	PAOZZ	21450	703077	BEARING, ROLLER, TAPE	2
9	PAOZZ	00447	428579	CUP, TAPERED ROLLER	4
10	PAOZZ	19207	7979312	SEAT, SPRING, AXLE	2
11	PAOZZ	19207	7979305	. SEAT, SPRING, AXLE	1
12	PAOZZ	96906	MS49005-2	. PLUG, PIPE	1
13	PAOZZ	19207	7979316	SADDLE, LEAF SPRING	2
14	PAOZZ	19207	7979365	BOLT, U	4
14	PAOZZ	19207	8741539	UOC: 131, 133, 684 BOLT, U	4
15	PAOZZ	96906	MS35338-55	UOC: 260, 671, 673, 674, 680, 681, 682 WASHER, LOCK	4
16	PAOZZ	19207	7979329	BOLT, MACHINE	4
17	PAOZZ	21450	712286	CONE ROLLER, INNER	2
18	PAOZZ	19207	7979349	SEAL, PLAIN ENCASED UOC: 131, 133, 260, 671, 673, 674, 680, 681, 682	2
19	PAOZZ	19207	7409553	RING, WIPER	2
20	PAOZZ	19207	7979264	RETAINER, PACKING	2
21	PAOZZ	78500	5X625	FELF, MECHANICAL, PRE	4
22	PAOZZ	19207	7979265	WASHER, FLAT	2
23	PAOZZ	19207	7979268	PLUG, TUBE AND BRACK UOC: 131, 133, 260, 671, 674, 680, 681, 682, 684	2
24	PAOZZ	19207	7979366	NUT, PLAIN, HEXAGON	8
25	PAOZZ	96906	MS35338-53	WASHER, LOCK	8
END OF FIGURE					

Current part is item (21) on diagram. Available at www.oshkoshequipment.com